

NOTES:

1. CONSTRUCTION: MOUNTED IN BLACK ANODIZED RING
2. COATING (APPLY ACROSS COATING APERTURE)

DURABILITY: MIL-C-48497A
 PERFORMANCE SPECIFICATIONS:
 CWL: 980
 FWHM: 49
 REFLECTION %: >99
 TRANSMISSION %: >90

3. POWER, IRREGULARITY, AND SURFACE QUALITY SPECIFICATIONS
 APPLY ACROSS CLEAR APERTURE
4. TRANSMITTED WAVEFRONT DISTORTION RMS@ <1λ
5. ROHS COMPLIANT

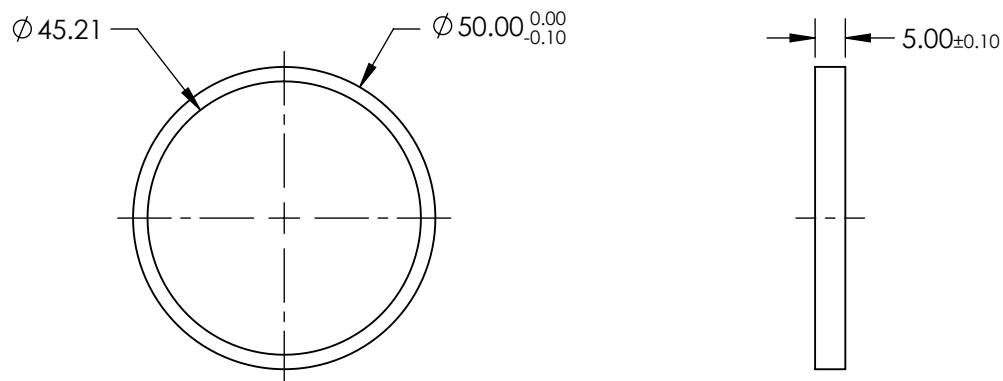
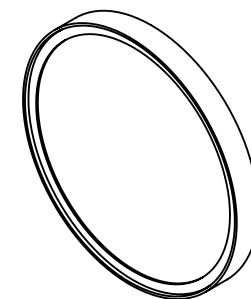

**FOR INFORMATION ONLY:
 DO NOT MANUFACTURE
 PARTS TO THIS DRAWING**

SPECIFICATIONS SUBJECT TO CHANGE WITHOUT NOTICE
 DIMENSIONS ARE FOR REFERENCE ONLY



	S1	S2	THIRD ANGLE PROJECTION		TITLE	OD4, Ø50mm, 980nm, NOTCH FILTER	
SHAPE	PLANO	PLANO	ALL DIMS IN	mm	DWG NO	67131	SHEET 1 OF 1
SURFACE QUALITY	60-40	60-40					
CLEAR APERTURE	Ø45.21	Ø45.21					