

NOTES:

1. SUBSTRATE MATERIAL:  
RUBY DOPED SAPPHIRE (Al<sub>2</sub>O<sub>3</sub>)
2. COATING - NONE
3. FINISH: POLISHED
4. SPHERICITY:  
0.64μm
5. RoHS COMPLIANT

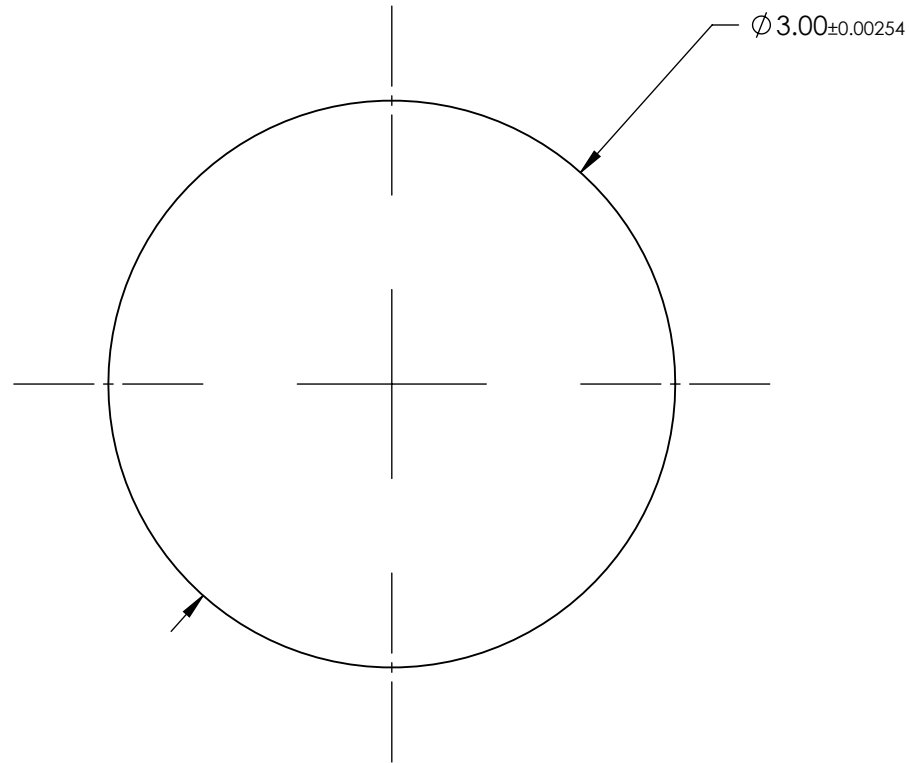

SPECIFICATIONS SUBJECT TO CHANGE WITHOUT NOTICE  
DIMENSIONS ARE FOR REFERENCE ONLY

**FOR INFORMATION ONLY:  
DO NOT MANUFACTURE  
PARTS TO THIS DRAWING**

**EO**® Edmund Optics®

THIRD ANGLE PROJECTION		TITLE	3.0mm DIAMETER, RUBY BALL LENS	
ALL DIMS IN	mm	DWG NO	43645	SHEET 1 OF 1