

NOTES:

**FOR INFORMATION ONLY:  
DO NOT MANUFACTURE  
PARTS TO THIS DRAWING**

1. SUBSTRATE: Float Glass
2. COATING SPECIFICATION:

VIS Laser  
S1: R(abs) >97% @ 633nm

S2: 0

3. POWER, IRREGULARITY, AND SURFACE QUALITY SPECIFICATIONS  
APPLY ACROSS CLEAR APERTURE

4. ROHS COMPLIANT

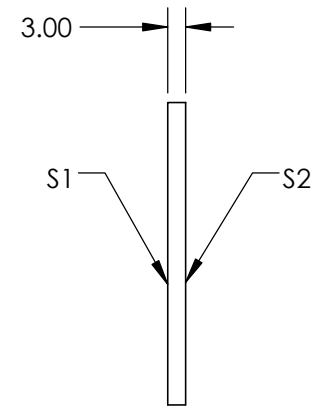
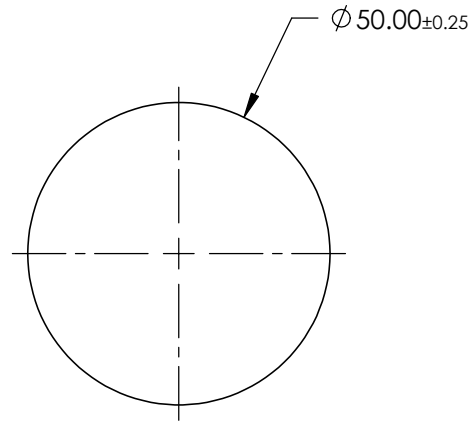
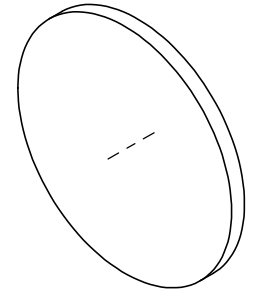

SPECIFICATIONS SUBJECT TO CHANGE WITHOUT NOTICE  
DIMENSIONS ARE FOR REFERENCE ONLY

**EO**® **Edmund Optics**®

	S1	S2	THIRD ANGLE PROJECTION		TITLE	50mm Diameter Laser Diode Mirror	
SHAPE	PLANO	PLANO			ALL DIMS IN	mm	DWG NO
SURFACE QUALITY	80-50	COMMERCIAL POLISH					
BEVEL	PROTECTIVE AS NEEDED	PROTECTIVE AS NEEDED					