

NOTES:

1. SUBSTRATE: GERMANIUM (GE)
2. COATING
 - S1: R(avg) <3.0% @ 3 - 5µm
 - S2: R(avg) <3.0% @ 3 - 5µm
3. EDGES: DIAMOND TURNED
4. CENTERING: 3-5 arcmin
5. RoHS: COMPLIANT
6. ASPHERIC SURFACE DESCRIBED BY THE FOLLOWING EQUATION AND COEFFICIENTS SHOWN IN TABLE BELOW

$$Z_{ASPH}(Y) = \frac{(\frac{1}{RADIUS}) * Y^2}{1 + \sqrt{1 - (1+k) * (\frac{1}{RADIUS})^2 * Y^2}} + D * Y^2 + E * Y^4 + F * Y^6 + G * Y^8 + H * Y^{10} + J * Y^{12} + L * Y^{14}$$

FOR INFORMATION ONLY:
DO NOT MANUFACTURE
PARTS TO THIS DRAWING

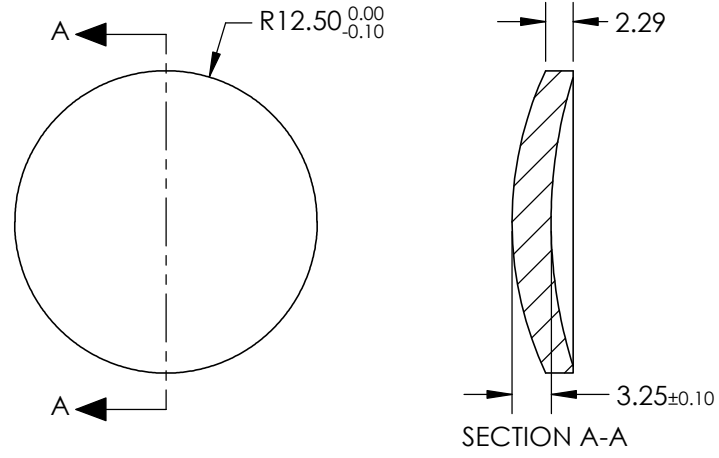

COEFFICIENT TABLE	
COEFFICIENT	S1
k	0.000000E+00
D	0.000000E+00
E	-3.9735336E-7
F	-6.3265251E-10
G	0.000000E+00
H	0.000000E+00
J	0.000000E+00
L	0.000000E+00

SPECIFICATIONS SUBJECT TO CHANGE WITHOUT NOTICE
DIMENSIONS ARE FOR REFERENCE ONLY

	S1	S2					
SHAPE	CONVEX	CONCAVE	EFL @ 4000nm: 30	Edmund Optics®			
RADIUS	29.460	40.000	BFL @ 4000nm: 27.52				
SURFACE ACCURACY	0.3µm	N/A	THIRD ANGLE PROJECTION	TITLE	25mm DIA X 30mm FL 3-5µm COATED, GE ASPHERIC LENS		
SURFACE QUALITY	60-40	60-40	ALL DIMS IN	mm	DWG NO	68247	SHEET 1 OF 1
CLEAR APERTURE	90%	90%					
BEVEL	PROTECTIVE AS NEEDED	PROTECTIVE AS NEEDED					