

NOTES:

1. SUBSTRATE MATERIAL:  
FUSED SILICA

2. COATING (APPLY ACROSS CLEAR APERTURE)

S1: Broadband Dielectric  
R(avg) >98% @ 400 - 750nm (0 - 45°) ALL POLARIZATIONS  
R(avg) >99% @ 400 - 750nm (0°) ALL POLARIZATIONS  
S2: NONE

 FINE GROUND SURFACE

4. RoHS COMPLIANT

**FOR INFORMATION ONLY:  
DO NOT MANUFACTURE  
PARTS TO THIS DRAWING**

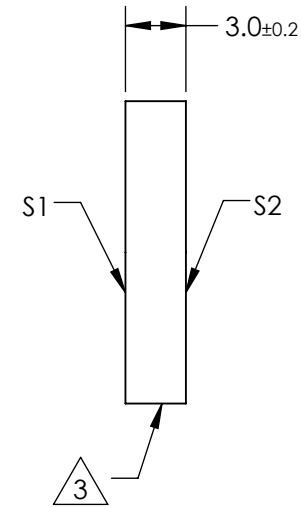
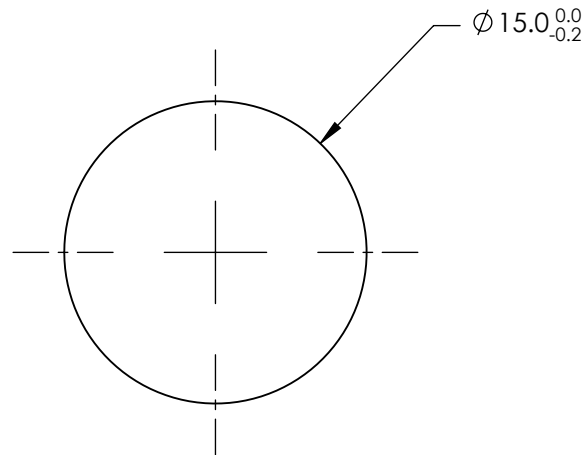

SPECIFICATIONS SUBJECT TO CHANGE WITHOUT NOTICE  
DIMENSIONS ARE FOR REFERENCE ONLY

REV. A	S1	S2
SHAPE	PLANO	PLANO
CLEAR APERTURE (%)	90	N/A
SURFACE QUALITY	20-10	COMMERCIAL POLISH
SURFACE FLATNESS	$\lambda/10$ (BEFORE COATING)	N/A
BEVEL	PROTECTIVE AS NEEDED	PROTECTIVE AS NEEDED

THIRD ANGLE  
PROJECTION

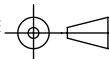

ALL DIMS IN

mm

 **Edmund Optics®**

TITLE

Ø15mm, 400 - 750nm BROADBAND  $\lambda/10$   
MIRROR

DWG NO

87369

SHEET  
1 OF 1